

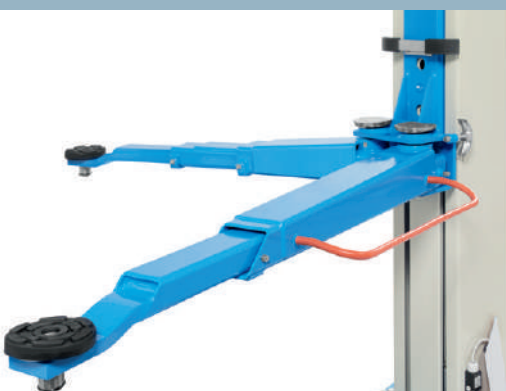

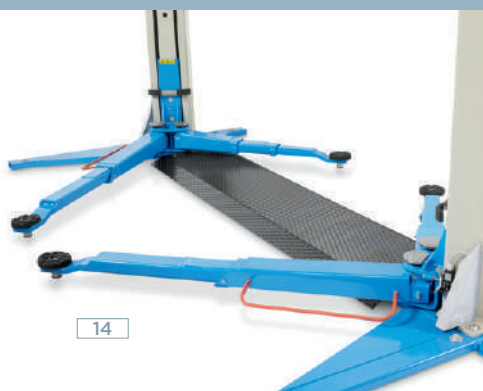

ART. 199/DELTA

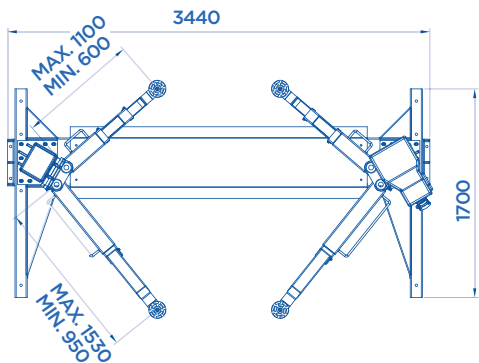
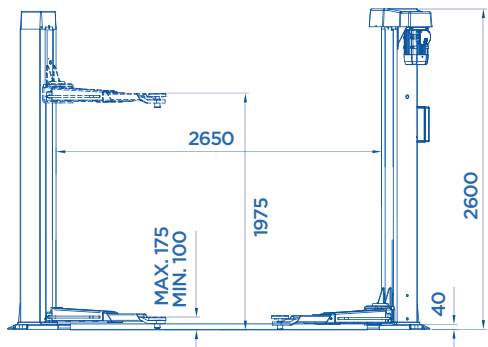

3500 KG



OPTIONAL Pag. 025

| | | | | |
|---|---|---|--|---|
| ART. |  |  | Motore trifase Three-phase motor Moteur triphasé Netzspannung |  |
| 199/DELTA | 3500 Kg | 4 KW | 400V • 50HZ | 850 |
|  | Potenza motore • Motor power • Puissance moteur • Motorleistung | | | |